



TSTLP®/TS-385B25RM Series Type 1 Lightning Current Arrester (CE Approval)

❖ **INTRODUCTION:** TS-385B25RM series Type 1 lightning current arrester, designed according to GB 18802.1 / IEC 61643-11, is for installation at LPZ 0A -1 or higher, protecting low voltage equipment against lightning and surge damages. Applied in SPD Type 1/Class I(Class B) for various power supply system.

Product Photo	TS-385B25RM/4 Dimension(mm)	TS-385B25RM/4 BCD(4+0)

❖ TECHNICAL DATA

Model Number	TS-385B25RM/4 TS-385B25RM/2 TS-385B25RM (4+0, 2+0, 1P)	TS-385B25RM/4 TS-385B25RM/2 TS-385B25RM (3+1, 1+1, N-PE)
4+0 for TN-S system; 3P for TN-C system 2+0 for TN system 3+1 for TN-S/TT system 1+1 for TN/TT system		
Rated voltage (max. continuous voltage)	Uc 385 VAC~	385 VAC~
Lightning impulse current (10/350)	I _{imp} 25 kA	25 kA 75 kA (N-PE)
Nominal discharge current (8/20)	I _n 100 kA	100 kA
Max. discharge current (8/20)	I _{max} 120 kA	120 kA
Voltage protection level	U _p ≤ 2.5 kV	≤ 2.5 kV ≤ 2.2 kV
Follow current extinguishing capability at U _c	I _f 32A fuse will not be triggered at 2kArms	32A fuse will not be triggered at 2kArms 100Arms (N-PE)
Response time	t _A ≤ 100ns	
TOV voltage	U _T 335V / 5sec	335V / 5sec 600V/200ms
Max. back up fuse (L)	200AgL/gG	
Max. back up fuse (L-L')	125AgL/gG	
Operating temperature range (parallel wiring)	T _{UP} -40°C...+80°C	
Operating temperature range (through wiring)	T _{US} -40°C...+60°C	
Relative humidity:	≤95% (25°C)	
Cross-sectional area	35mm ² solid / 50mm ² flexible	
Mounting on	35mm DIN rail	
Enclosure material	White/Red thermoplastic, UL94-V0	
standards	IEC 61643-11; GB 18802.1; YD/T 1235.1	
Certification	CE (LVD, EMC)	

❖ MAIN CHARACTER

- ✓ Combined SPD for three-phase TN / TT system
- ✓ Adopted hermetical GDT technology, high follow current extinguish capability
- ✓ Double thermal disconnection device , provide more reliable protection
- ✓ (SPD with WINDOWS indication only) Green Window will display red when fault occurs, remote alarm terminal at the same time.
- ✓ (SPD with both WINDOWS & LIGHTS indication), provide DOUBLE indications for users to check its working status : WINDOWS display GREEN and 3 Green lights will display HIGH GREEN when it's working OK; When fault occurs, the windows display RED color and The green lights go off once the fuse upstream break.



INSTALLATION INSTRUCTION

According to lightning protection zones concept, for installation at LPZ 0_A -1 or higher. It is usually installed in floor distribution-box or Class I main distribution-box

Fuse must be installed at the upstream of the SPD or the lightning arrester to make sure that protected system has double protection. The value of the fuse used in a SPD system should be conformed to:

1. The value of FUSE should not be larger than the max.withstand capacity of the SPD's backup fuse value.
2. Under the status of the max. current in the power supply & close loop circuit available current, the fuse should be able to disconnect when overloaded or short-circuited.

Take 1 & 2 into consideration, the fuse should be as large as possible to allow the maximum surge discharge of SPD.

INSTALLATION STEPS

- 1) Check the product for integrity of the package; make sure the product window indicates green.
- 2) Mount the SPD on 35 mm DIN rail.
- 3) Connect conductors, the cross-sectional area of cable must be larger than 16mm². The withstand voltage value of cable is not smaller than AC500V; ensure wiring reliable.
- 4) If need remote alarm, it should be connected signal lines to remote signal terminal 1 and 2, or 2 and 3 (When normal, 1 and 2 open, 2 and 3 close; when fault, the state is reversed).
- 5) Remote Contact: When the Green window display RED, 1 & 2 are connected; And the extra light will be on if the both terminals are connected with light.
- 6) After above, switch on the power supply and turn on the circuit breaker, if the SPD's window does not appear red, this indicates the unit is operating normally.
- 7) **For the SPD with 3 Green lights, it displays HIGH GREEN when it's working normal; The green lights go off once the fuse upstream break.**

Regularly inspect the operating status, especially after lightning. Once the fuse upstream break, or the SPD's fault appear, electrician should check/replace the SPD.

INSTALLATION DIAGRAM (4+0)

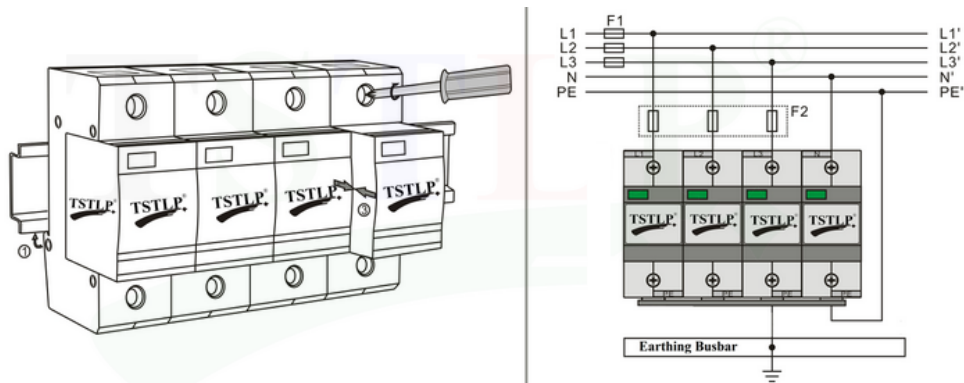

INSTALLATION DIAGRAM (3+1)

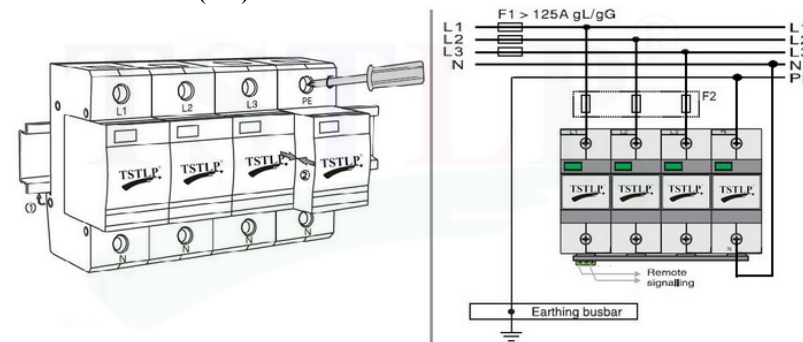

INSTALLATION DIAGRAM (2+0)

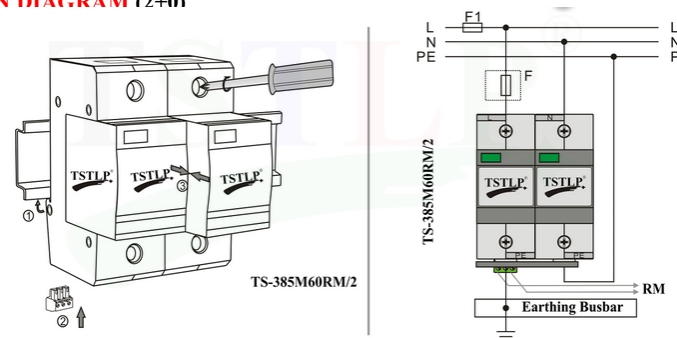

INSTALLATION DIAGRAM (L-N/PE)

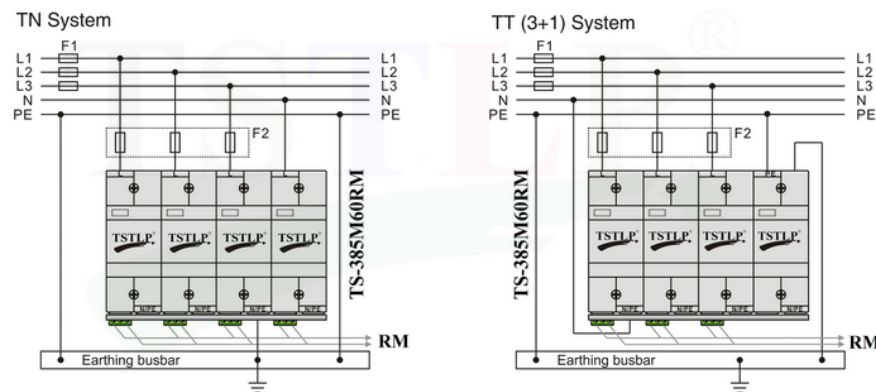

WARNING:

1. The device must be installed by electrically skilled person, conforming to national standards & safety regulations.
2. It is recommended that installation should be done under power off condition.